

PowerBoss[®]
The Power of Clean

***SERVICE MANUAL
ADMIRAL 30 & 32***



● 1 Remarks	4
● 2 General	5
– 2.1 Setting	6
– 2.2 Brief description	7
– 2.2.1 Vacuuming OFF/soiled water tank full	8
– 2.2.2 Initial position of machine	9
● 3 Check and set machine type, LDS and options, view and delete last error	11
– 3.1 Check and set machine type	15
– 3.2 Check and set options	16
– 3.3 Check and set LSD	18
– 3.4 View and delete last error in display	20
● 4 Program various cleaning cycles as a function of drive rheostat setting (check and set)	21
● 5 Program functions	23

- **6 Particular settings according to customer's requirements (last error display and water stage selection)**
33
- 6.1 Display of last error 36
- 6.2 Water stage when start scrubbing 37
- 6.3 Water stage when start cleaning with green ADMIRAL key 38
- 6.4 Water stage when start cleaning with green bordered key (increased brush pressure) 39
- **7 Settings on power electronic (A2)**
40
- **8 Water pump**
41
- 8.1 Water pump standstill recognition 43
- **9 Diagnosis LED for drive module** **44**
- 9.1 Signal measuring at the drive control unit 50
- 9.2 Settings at the accelerator pedal 57
- 9.2 A4:X51 plug assignment For Internal Office Use Only 60
- **10 Error reference chart with information on service display**

1. REMARKS

PowerBoss
The Power of Clean

● **Caution:**

- Before working at the machine make sure that no voltage applies (disconnect battery plug); except for cases of current and voltage measurement.
- When replacing the stripe fuses only loosen the screws. Do not remove them completely to avoid short-circuit hazard.
Place the new stripe fuses completely i.e. evenly under the screws.
- Measure starting and operating voltage after any repair action to detect any eventual defect.
- The applicable safety and accident prevention regulations as imposed by law have to be respected when working at the machine.

2. GENERAL

- The ADMIRAL 30/32 uses a service display integrated in the hourmeter display. When turning the key switch ON, a 4-digit display will appear for about 3 seconds, describing the software version (e.g. 3.017), then another 4-digit display may appear which repeats the last error, followed by the hourmeter display.
- In case of malfunction during operation, a red error LED alights and a buzzer sounds. The actual **error code** (4-digit number in the service display) **with flashing dots** between the numbers will appear in the service display. Only if these criteria are fulfilled the error is actual.
- The versions 7090.10/20 of the ADMIRAL 30/32 machines are equipped with an integrated charger unit; the versions 7090.30/40 need an external charger unit. The versions 7090.10/30 work with plate brushes, the versions 7090.20/40 work with cylinder brushes.
- The separate instruction manual of the integrated charger unit is enclosed in the machine. The working and error codes of the charger are enclosed in the charger manual.

2.1 SETTINGS



The following settings on the control unit (A1)/control panel of each machine must be defined and checked:

- machine type
- LDS (low discharge signal sender)
- options
- delete last error display after elimination
- program variants with a given drive rheostat position

Settings via control panel which may be defined by the customer:

- display of the last (eliminated) error when turning the machine ON
- water stage selection when start cleaning

Settings on power electronic module:

DIP-switch for electronic circuit breakers

2.2 BRIEF DESCRIPTION

The following electronic modules control the machine:

- control unit (A1)
- power electronic (A2), referred to as "module 1" in the diagrams
- drive control unit (A4)
- control panel (A3)

The control unit (A1) ensures all control and monitoring functions in the machine except for the drive control unit.

No particular error code is displayed when an error occurs at the drive control unit since it is equipped with an independent diagnosis display (flashing LED at the drive control unit) (see chapter 9).

The keys for scrubbing, vacuuming and the green ADMIRAL key for combined cleaning can be used autonomously, only the selected function being active.

2.2.1 VACUUMING OFF/ soiled water tank full

PowerBoss
The Power of Clean

The vacuuming function is turned OFF either by operator's key action or automatically when the signal "Soiled water tank full" applies.

Operator turns vacuuming OFF:

- squeegee is lifted
- suction motor turned OFF with a delay of 15 seconds

Turned OFF when tank full:

- the "soiled water tank full" switch opens as soon as the tank is filled
- If the switch opens 3 seconds or longer (spill protection) the squeegee is lifted and the suction motor turned off with a delay of 15 seconds.

2.2 INITIAL POSITION OF THE MACHINE



- After turning ON the machine, all components are set to “initial position” after the seat contact switch has closed.
- The lifting elements will lift if they have not been turned OFF in top final position by the micro switch integrated in the lifting element.
- The motors are turned OFF and the LEDs on the control panel for cleaning elements extinguish.
- The seat contact switch is connected to the control unit A1 at A1:X7:11 + 12.
- The A1 control unit's reaction to activation (opening) of the seat contact switch is delayed by 2 seconds i.e. if, during operation, the contact is opened for more than 2 seconds, the motors stop and brush head and the squeegee is lifted.
- If the switch is closed again within this delay, operation is not interrupted.
- When the machine is switched ON without the seat switch being closed or when the switch is opened for more than 2 seconds all functions (driving and cleaning) are now inhibited.

3. CHECK AND SET MACHINE

PowerBoss
The Power of Clean

Check and set machine type, LDS and options, view and delete last error

The settings described in this paragraph must by all means be checked and modified if required and in particular after replacing the electronic module.

Figure 1 shows the control panel for B750R with plate brush (7090.10/30).

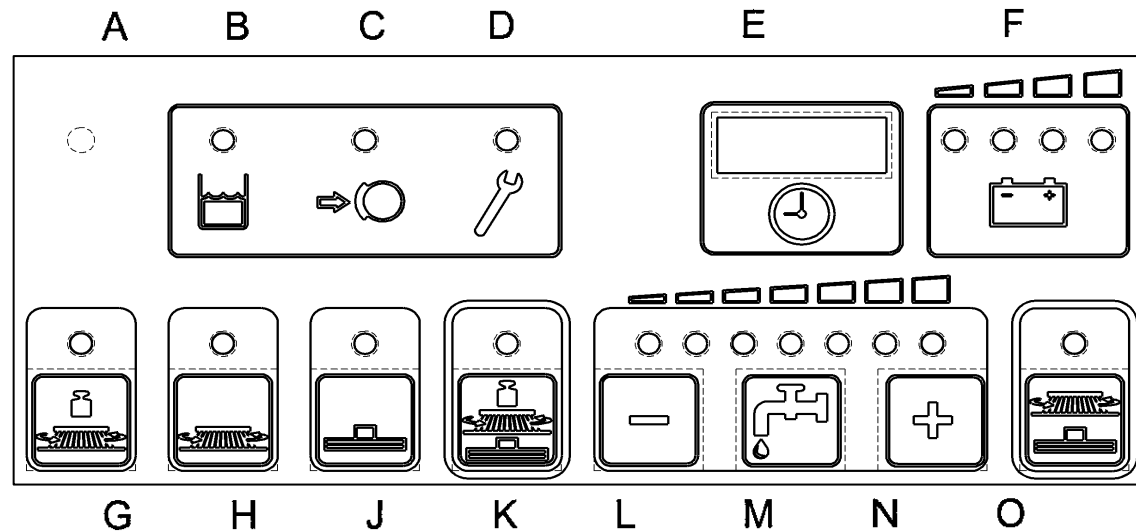

For Internal Office Use Only

3. CHECK AND SET MACHINE TYPE

PowerBoss
The Power of Clean

- **Check and set machine type, LDS and options, view and delete last error**
- Figure 2 shows the control panel of B750R with cylinder brush (7090.20/40).

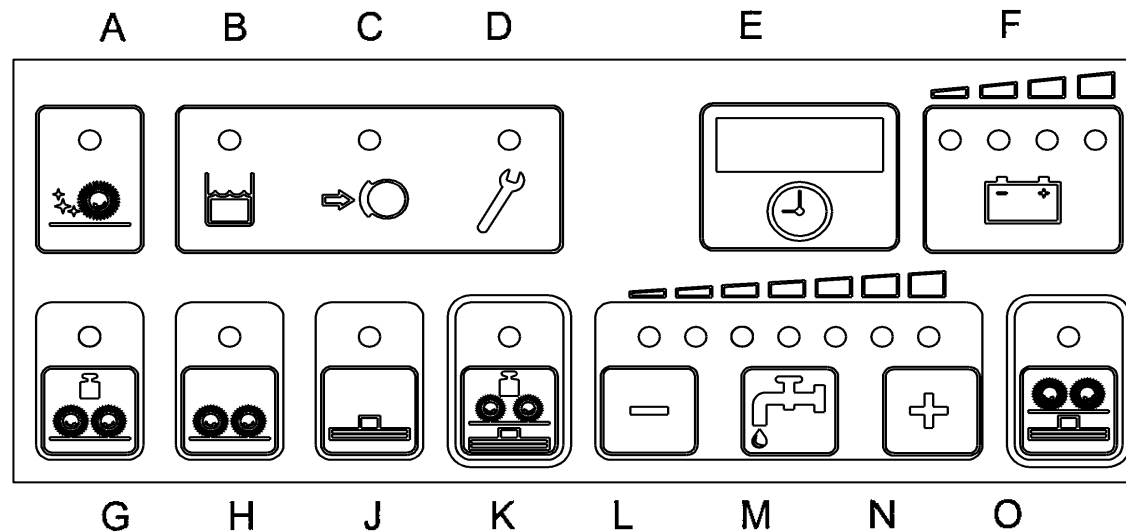

For Internal Office Use Only

3. CHECK AND SET MACHINE TYPE



Entry in the programming step

1. Turn OFF machine with the key switch.
2. Depress "G" and "H" keys the same time and hold, turn ON with the key switch.
3. Hold both keys until a number (software version) appears in the display, then release both keys.

The set machine type is displayed automatically. Use the "N" key for display of option and LDS settings or thereafter for display of the last (eliminated) error. Use the "L" key to step back for display of previous codes.

Quit the session by turning key switch OFF.

3. CHECK AND SET MACHINE TYPE

type)

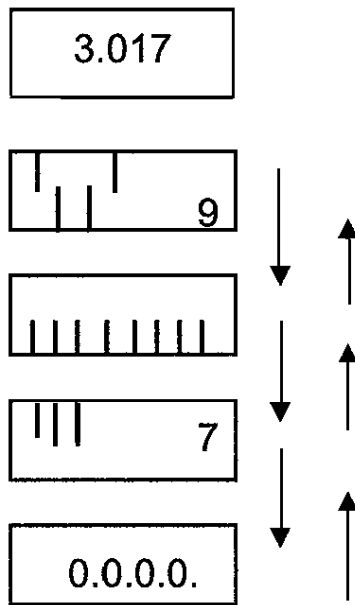

“N”

Software version, next display appears automatically

Machine type setting: 9 stands for B750R

Option settings

LDS setting (in relation to the battery

Display of last error and reset

“L”

3.1 CHECK AND SET MACHINE TYPE

PowerBoss[®]
The Power of Clean

1. Setting the correct machine type is absolutely necessary. To do so use the DIP-switch A on the control unit (A1).
2. For the B750R type the first and the last bar have to be positioned in the top line and the second and third bar in the bottom line. This setting results in the displayed cipher 9.
3. If the display does not correspond with these parameters, correct the DIP-switch combination.

B750R	1: ON	(= bars in top line)
	2: OFF	(= bars in bottom line)
	3: OFF	(= bars in bottom line)
	4: ON	(= bars in top line)

3.2 CHECK AND SET OPTIONS



1. The setting of all options on the DIP-Switch B of the control unit (A1) is absolutely necessary.
2. The DIP-switches are assigned as follows:
 - 1 - 3: unassigned, i.e. "OFF"
 - 4: OFF
 - 5: OFF
 - 6: plate brush or cylinder brush unit
(ON = cylinder brush; OFF = plate brush)
 - 7 - 8: unassigned, i.e. "OFF"
3. The only option switch used in the B750R is switch S6. It is used to toggle between plate brush and cylinder brush.

These machines are not provided for more options and all switches have to be set to OFF.

3.2 CHECK AND SET OPTIONS

PowerBoss[®]
The Power of Clean

Control unit (A1)

Steuerelektronik (A1)

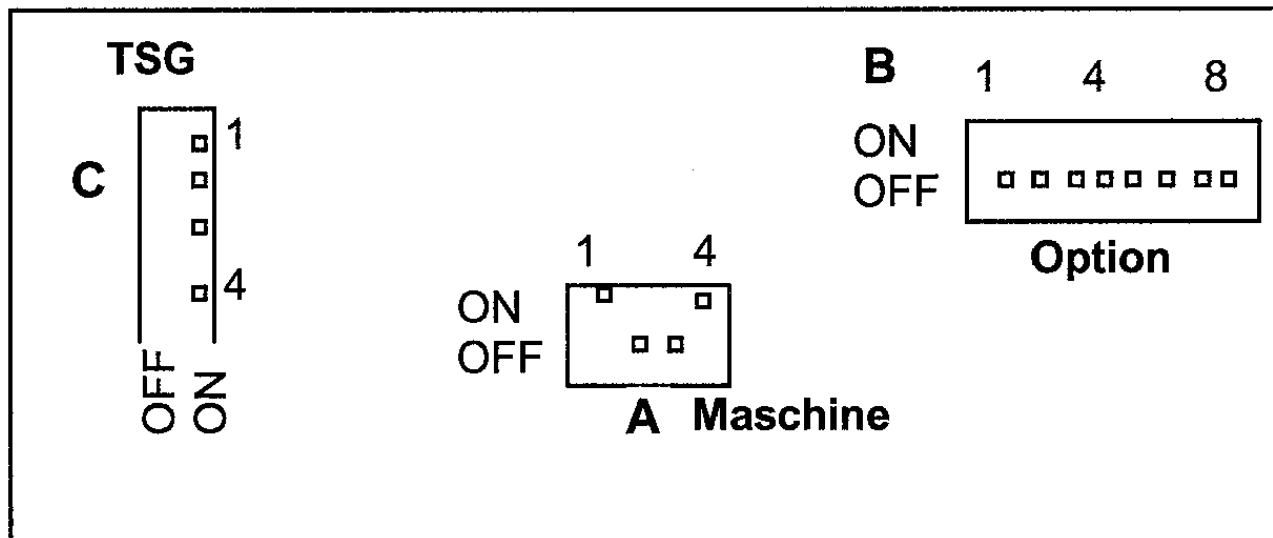

For Internal Office Use Only

3.3 CHECK AND SET LDS



1. The LDS Must set to the correct battery type.
2. The LDS is set following this chart.

	Display Code ®	2	3	4	5	6
	PowerBoss Lead Acid Deep Cycle Non - OEM Battery	PowerBoss Lead Acid Deep Cycle Battery	PowerBoss Industrial – Armor Plated Non - OEM Battery	PowerBoss Industrial – Armor Plated Battery	Gel	European Standard Gel
1	0	1	0	1	0	1
2	1	1	0	0	1	1
3	0	0	1	1	1	1
4		ON = 24 V				

For Internal Office Use Only

3.3 CHECK AND SET LDS



“1” means ON; “0” means OFF

“Foreign” means all batteries **not** delivered by **Hako**.

Reset voltage: **approx. 25.5V**.

●**Caution:** The maintenance-free Gel batteries are no longer differentiated by the manufacturer (Sonnenschein or Deta). The setting is related to the type of battery used e.g. setting 6 for GIV batteries and setting 7 for PzV batteries, irrespective of the manufacturer. (For historic reasons, the denominations Sonnenschein and Deta are not eliminated in the documents.)

3.4 VIEW AND DELETE LAST ERROR IN DISPLAY



•Viewing

1. Depress "N" key three times, the 4-digit error code with flashing dots will appear (last and eliminated error).
2. Quit the session by turning the key switch OFF (must not be executed when passing to "deleting").

Deleting

1. Depress "O" key and hold until 0.0.0.0. is displayed
2. Release key, turn key switch OFF and ON.
3. 0.0.0.0. will appear (after display of software version) for approx. 3 seconds followed by the hourmeter display.
4. You may view the last error in the menu as described under "View", since such data cannot be deleted in the menu.
5. Quit the session by turning the key switch OFF

4. PROGRAM VARIOUS



**Program various cleaning cycles as a function of drive rheostat setting
(check and set)**

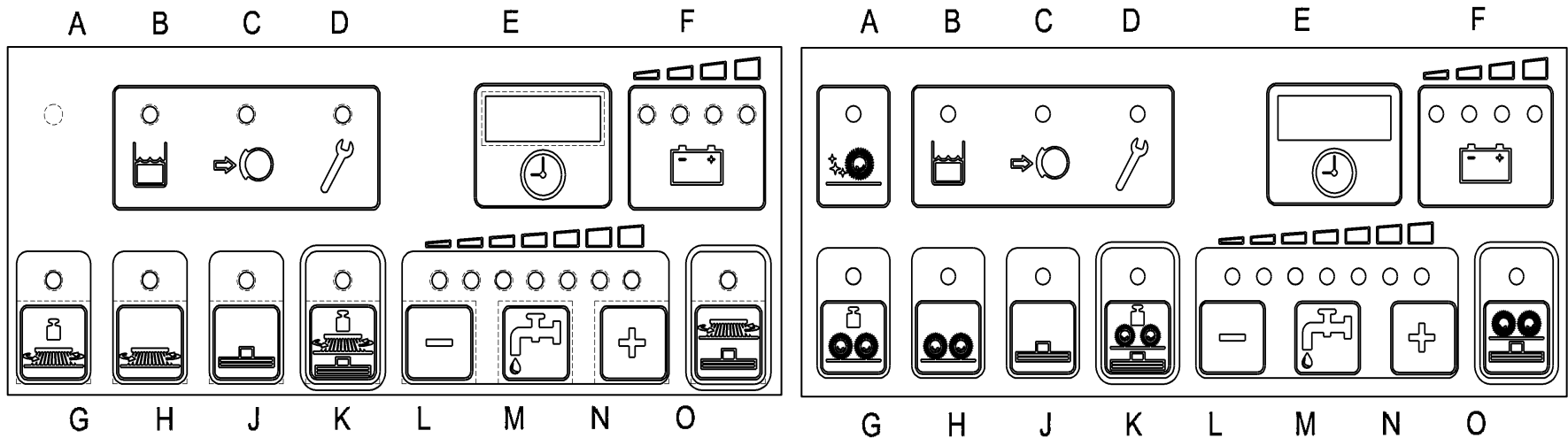

4. PROGRAM VARIOUS

PowerBoss
The Power of Clean

Checking

1. Turn machine OFF with key switch.
2. Depress "N" and "O" key the same time and hold, turn key switch ON
3. Hold both keys until a number (software version) appears in the display, thereafter release both keys.
4. The programs may also be viewed by depressing the "L" key (down) or the "N" key (up).
5. The active program is marked by a dash and the number.

●Setting

1. Select the required program with the "L" or "N" key
2. Depress "O" key and hold until the dash appears with the number. The program is
now saved and active.

●Note: Quit the session by turning the key switch OFF.

For Internal Office Use Only

5. PROGRAMS FUNCTIONS



The description of program functions requires the “brushing” and/or “vacuuming” function being turned ON. All programs allow normal cleaning or vacuuming in the ‘forward’ drive rheostat position. The following chart shows the differences for ‘neutral’ and ‘reverse’ drive rheostat position.
(up to software version 3.017).

Program Drive code	rheostat setting	Function with a given drive rheostat	
		Brush head	Squeegee
1	Neutral	Brushes and water ON	Vacuuming remains ON
	Reverse	Brushes and water ON	Squeegee OFF + lifted

For Internal Office Use Only

5. PROGRAMS FUNCTIONS

PowerBoss
The Power of Clean

● Program code	Drive rheostat setting	Function with a given drive rheostat	
		Brush head	Squeegee
2	Neutral	Brushes and water ON	Squeegee OFF + lifted
	Reverse	Brushes and water ON	Squeegee OFF + lifted
3	Neutral	Brushes and water OFF	Vacuuming remains ON
	Reverse	Brushes and water ON	Squeegee OFF + lifted

For Internal Office Use Only

5. PROGRAMS FUNCTIONS

PowerBoss[®]
The Power of Clean

● Program code	Drive rheostat setting	Function with a given drive rheostat	
		Brush head	Squeegee
4	Neutral	Brushes and water OFF brush head lifted (3 seconds delay for brushes to prevent brushes from being turned OFF when switching from forward to reverse mode)	Squeegee OFF + lifted
	Reverse	Brushes and water ON	Squeegee OFF + lifted

For Internal Office Use Only

5. PROGRAMS FUNCTIONS

PowerBoss
The Power of Clean

● Program code	Drive rheostat setting	Function with a given drive rheostat	
		Brush head	Squeegee
5	Neutral	Brushes and water OFF (3 Sec. delay)	Squeegee OFF + lifted
	Reverse	Brushes and water ON and lowered	Squeegee OFF + lifted
6	Neutral	Brushes and water OFF, brush head remains lowered	Vacuuming remains ON
	Reverse	Brushes and water remain OFF	Squeegee OFF + lifted

For Internal Office Use Only

5. PROGRAMS FUNCTIONS

On from software version 3.018 additional program functions are implemented to the machine control. This allows to work on sensitive floor without leaving marks on the floor. Remark: as a result of this short switch off times, the life time of brush motor and lifting element will decrease.

Program code	Drive rheostat setting	Function with a given drive rheostat	
		Brush head	Squeegee
1	Neutral	Brushes and water ON	Vacuuming remains ON
	Reverse	Brushes and water ON	Squeegee OFF + lifted

5. PROGRAMS FUNCTIONS

PowerBoss
The Power of Clean

● Program code	Drive rheostat setting	Function with a given drive rheostat	
		Brush head	Squeegee
2	Neutral	Brushes ON, water OFF	Vacuuming remains ON
	Reverse	Brushes and water ON	Squeegee OFF + lifted
3	Neutral	Brushes and water OFF	Vacuuming remains ON
	Reverse	Brushes and water ON	Squeegee OFF + lifted

For Internal Office Use Only

5. PROGRAMS FUNCTIONS

PowerBoss
The Power of Clean

● Program code	Drive rheostat setting	Function with a given drive rheostat	
		Brush head	Squeegee
4 (long switch Off time)	Neutral	Brushes and water OFF brush head lifted (3 seconds delay for brushes to prevent brushes from being turned OFF when switching from forward to reverse mode)	Squeegee OFF + lifted
	Reverse	Brushes and water ON	Squeegee OFF + lifted

For Internal Office Use Only

5. PROGRAMS FUNCTIONS

PowerBoss
The Power of Clean

● Program code	Drive rheostat setting	Function with a given drive rheostat	
		Brush head	Squeegee
5 (long switch OFF time)	Neutral	Brushes and water OFF (3 Sec. delay) brush head lifted	Vacuuming remains ON
	Reverse	Brushes and water ON and lowered	Squeegee OFF + lifted
6 (medium switch OFF time)	Neutral	Brushes and water OFF, brush head remains lowered	Vacuuming remains ON
	Reverse	Brushes and water remain OFF	Squeegee OFF + lifted

For Internal Office Use Only

5. PROGRAMS FUNCTIONS

PowerBoss
The Power of Clean

● Program code	Drive rheostat setting	Function with a given drive rheostat	
		Brush head	Squeegee
7 (short switch OFF time)	Neutral	Brushes and water OFF (less than 1 sec)	Vacuuming remains ON
	Reverse	Brushes ON water OFF	Squeegee OFF + lifted
8 (long switch OFF time)	Neutral	Brushes and water OFF,	Vacuuming remains ON
	Reverse	Brushes and water ON	Squeegee OFF + lifted

For Internal Office Use Only

5. PROGRAMS FUNCTIONS

PowerBoss[®]
The Power of Clean

The water supply, brush or vacuuming function LED or the Hakomatic key (green key) is flashing if the selected function is turned OFF due to the drive rheostat setting.

*The brush motors switch off with a delay of 3 seconds. This delay precludes switching off in case of direction alteration but allows it in neutral rheostat position.

6. PARTICULAR SETTINGS

PowerBoss
The Power of Clean

Particular settings according to customer's requirements (last error display and water stage selection)

The settings described in this paragraph may be modified following the customer's requirements. The settings made in the factory may be altered.

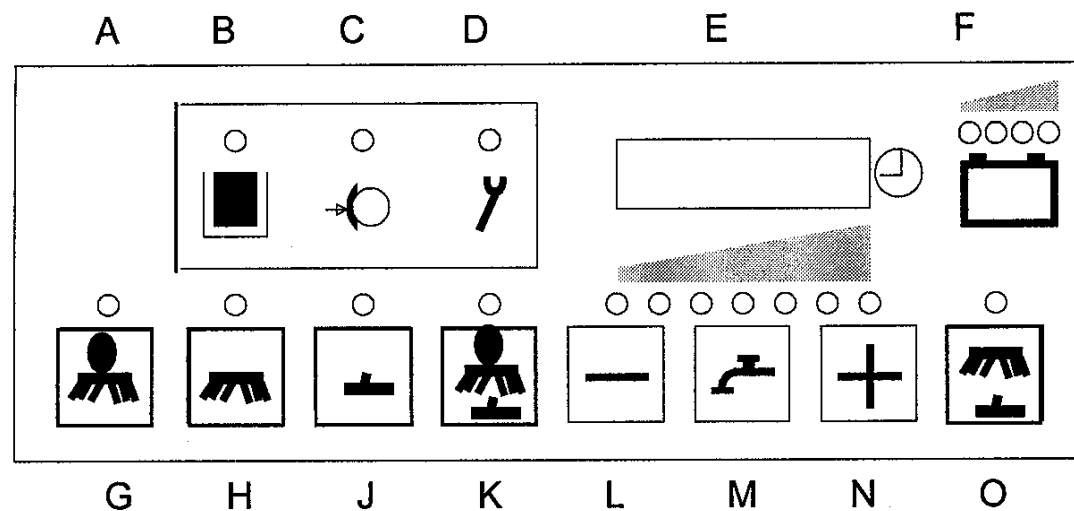

For Internal Office Use Only

6. PARTICULAR SETTINGS

PowerBoss[®]
The Power of Clean

Entry in the programming step

1. Turn machine OFF with key switch.
2. Depress "G" and "O" key the same time and hold, turn key switch ON.
3. Hold both keys until a number (software version) appears in the display, then release both keys.

The following programmed settings will appear automatically in the display:

last (eliminated) error display when turning ON: yes/no water stage when start cleaning (scrubbing only): last selected stage or middle stage

water stage when start cleaning (with green Hakomatic key): last selected stage or stage 2

water stage when start cleaning (with green bordered key for increased brush pressure): last selected stage or stage 6

6. PARTICULAR SETTINGS

PowerBoss
The Power of Clean

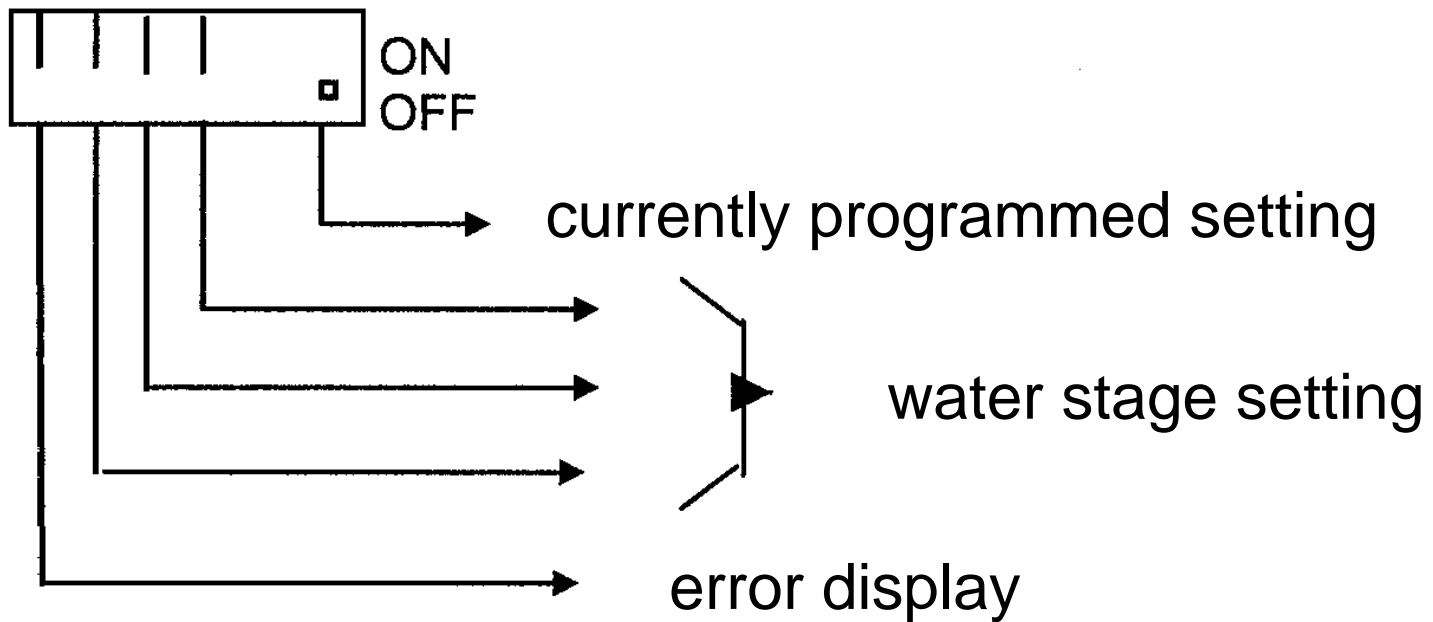

For Internal Office Use Only

6.1. DISPLAY OF LAST ERROR



1. Select required setting with "L" and "N" keys.
2. The bar of the setting to be modified is flashing.
3. Move the bar up or down with "M" key.
Up = ON = error code (of eliminated error) will appear for approx. 3 seconds in the display after turning ON
Down = OFF = error code (of eliminated error) is not displayed.
4. The setting is saved by pressing the green key ("O" key) until the dot appears in the display at the right bottom.

6.2. WATER STAGE WHEN STARTING TO SCRUB



1. Select required setting with "L" and "N" keys.
2. The bar of settings to be modified is flashing.
3. Move the bar up or down with "M" key.
Up = ON = last selected stage is set
Down = OFF = middle stage is always set
4. The setting is saved by pressing the green key ("O" key) until the dot appears in the display at the right bottom.

6.3 WATER STAGE

PowerBoss[®]
The Power of Clean

Water stage when start cleaning with green Hakomatic key

1. Select required setting with "L" and "N" keys.
2. The bar of settings to be modified is flashing.
3. Move the bar up or down with "M" key.
Up = ON = last selected stage is set
Down = OFF = 2nd stage is always set
4. The setting is saved by pressing the green key ("O" key) until the dot appears in the display at the right bottom.

6.4 WATER STAGE WHEN STARING TO CLEAN

PowerBoss[®]
The Power of Clean

Water stage when start cleaning with green bordered key (increased brush pressure)

1. Select required setting with "L" and "N" keys.
2. The bar of settings to be modified is flashing.
3. Move the bar up or down with "M" key.
Up = ON = last selected stage is set
Down = OFF = 6th stage is always set
4. The setting is saved by pressing the green key ("O" key) until the dot appears in the display at the right bottom.

7. SETTINGS ON POWER ELECTRONICS (A2)

PowerBoss[®]
The Power of Clean

The correct DIP-switch settings on the power electronic (A2) are necessary since they have an influence on the electronic circuit breaker values for the lifting elements (brush head and squeegee).

DIP-switch settings:

1: OFF

2: ON

Circuit breaker values:

Brush head: 5.7 A

Squeegee: 1.9 A

8.0 WATER PUMP

For check purpose of the water pump function, the voltage of the different stages can be measured on power electronic module (A2:X2:6+7). In case of measurement with measuring device Fluke 87, water in tank but suction turbine turned OFF, the result is:

	<u>plate brush</u>	<u>cylindrical brush</u>
stage 1:	xxx V (cannot be evaluated because of value variation caused by the pulses)	xxx V
stage 2:	xxx V (cannot be evaluated because of value variation caused by the pulses)	xxx V
stage 3:	approx. 5.0 V	5,7 V
stage 4:	approx. 6.7 V	6,5 V
stage 5:	approx. 8.7 V	7,5 V
stage 6:	approx. 13.2 V	8,4 V
stage 7:	approx. 17.8 V	9,4 V

When not using the indicated measuring device the result may vary since the voltage is pulsed. The value depends on the battery voltage as well. In the present case measurement was executed with charged battery and three green LEDs alight.

8. WATER PUMP

PowerBoss
The Power of Clean

- A good basis is measuring the water quantities.
- Let the pump run and measure the delivered quantity of water per minute.
- The quantities are indicated in the operating instructions as follows:

● Stage	1	2	3	4	5	6	7
● ● plate ● brush	1,0	1,3	1,6	2,0	2,4	3,6	5,2
● cylindrical ● brush	1,5	1,6	1,8	2,3	2,9	3,1	3,2

● Water quantity l/min

- If voltage supply of the pump is as required but the measured water quantity does not
- correspond with the indicated parameters, check the hoses for clogging or damage;
- check the solenoid valve for opening correctly, and the function of the diaphragms of
- the valve plate in the pump.

8.1 WATER PUMP STAND STILL RECOGNITION

PowerBoss[®]
The Power of Clean

If the pump does not deliver water to the brushes due to clogging of the hoses the so-called standstill recognition is activated.

Automatic standstill recognition for water pump:

The electronic module allows protection of the water pump if the pump does not deliver correctly. This means if the pump takes in water from the tank and cannot deliver it to the brushes, a pressure builds at the pump. Without being protected by the electronic module the pump would deliver against this pressure and could be damaged.

The electronic module detects the blocked delivery and automatically switches the pump off for 2 seconds. After this delay, the pump is briefly switched on again and it is simultaneously measured whether delivery of water to the brushes is free or blocked.

If delivery is as required, the pump remains ON in the selected stage. If the pressure still exists, the pump is switched off again for 2 seconds. This procedure is repeated until the error is remedied.

9. DIAGNOSIS LED for DRIVE MODULE

PowerBoss
The Power of Clean

The LED is located on the drive module

LED shows	Malfunction	Remarks
OFF	Drive module is inoperable	Voltage supply interrupted Check fuses and wiring; No release signal at A4:X51:2
ON	Drive module is serviceable	Drive module function OK
2 signals	Wrong start sequence	Accelerator actuated and direction selected, then ON with key switch = no reaction; return to neutral position

For Internal Office Use Only

9. DIAGNOSIS LED for DRIVE MODULE

PowerBoss[®]
The Power of Clean

LED shows	Malfunction	Remarks
3 signals	"M" and "B-" short-circuited	Check cable to drive motor; check carbon brushes; Check chassis of the machine for potential, if OK but error code displayed, replace the drive module

For Internal Office Use Only

9. DIAGNOSIS LED for DRIVE MODULE

PowerBoss
The Power of Clean

LED shows	Malfunction	Remarks
4 signals	Direction contactor stuck	Do contactors switch and do the correct direction selection signals apply at the drive control unit? Check motor connections for short circuit or contact to chassis and remedy if required since chassis has to be free of potential; Check for leakage current between battery and chassis. Check cable to drive motor; check carbon brushes; if OK but error code displayed, replace the drive module

For Internal Office Use Only

9. DIAGNOSIS LED for DRIVE MODULE

PowerBoss
The Power of Clean

LED shows	Malfunction	Remarks
5 signals	Direction contactors do not close or no connection to drive motor	Do contactors switch and do the correct direction selection signals apply at the drive control unit? Check cable to drive motor; check carbon brushes; if OK but error code displayed, replace the drive module
6 signals	Drive rheostat or cable connection interrupted	Check drive rheostat and wiring, possible loose contact at the plug connectors Is drive rheostat not in neutral position when machine is turned ON?

For Internal Office Use Only

9. DIAGNOSIS LED for DRIVE MODULE

PowerBoss
The Power of Clean

LED shows	Malfunction	Remarks
7 signals	Battery low, less than 13 Volts	Measure battery voltage under load (measure at input of the drive control unit as well), Check connections and fuses

For Internal Office Use Only

9. DIAGNOSIS LED for DRIVE MODULE

PowerBoss[®]
The Power of Clean

LED shows	Malfunction	Remarks
8 signals	Excessive temperature of drive module (70 °C or more)	Is travel drive smooth? Correct position of parking brake? Excessive uphill riding? Measure operating voltage of the motor line "A2" at full throttle on level ground using a clip-on current transformer (approx. 26A max. at transport ride and 30A max. at cleaning ride) Check correct mounting of drive control unit in the machine

For Internal Office Use Only

9.1 SIGNAL MEASURING AT THE DRIVER CONTROL UNIT

PowerBoss[®]
The Power of Clean

Check the following items when testing the drive control unit. If the respective signals do not apply, the drive control unit does not work sufficiently.

In the circuit diagram the drive control unit is designated with A4.

When testing the drive control unit, be supported by the circuit diagram and check the

connections there since the complete procedure became more complex by releasing via A1, closing the drive rheostat switch, the direction switch and the K4 relay. There is function interaction and the switches and the relay are connected in series.

Note: The red drive control unit cable with integrated fuse is not connected and remains free even after replacement of the drive control unit.

9.1 SIGNAL MEASURING AT THE DRIVER CONTROL UNIT

PowerBoss[®]
The Power of Clean

1. Self-test

Before the drive control unit is operable, it executes a self-test. This self-test starts automatically after switching on the machine with key switch.

If, during this self-test, the drive control unit detects an error, the LED on the unit flashes to signal non-operability. The machine will then not start riding.

Key switch ON -> the battery + signal has to apply at A4:X51:2.

Then the self-test starts and the result is signalled by the LED of the drive control unit.

Only if the LED lights permanently, the drive control unit is operable. If the LED flashes, check for possible causes of error with the table below.

9.1 SIGNAL MEASURING AT THE DRIVER CONTROL UNIT

PowerBoss
The Power of Clean

2. Drive direction

The drive direction is set via the direction selector switch S7 but closing of this switch alone is not sufficient for signalling the selection to the drive control unit. Simultaneous releasing of A1, closing of the drive rheostat switch S8 and the K4 relay switching contact is required.

Release on A1

The control unit A1 monitors the seat contact switch and all other functions of the machine. The control unit releases driving only after all conditions (= seat contact switch closed) have been met. Releasing means that the contacts A1:X4:3 and A1:X3:1 are connected on the A1 module to initiate transfer of the battery minus signal from the A1:X4:3 contact to the A1:X3:1 contact. Only if the battery minus signal applies at A1:X3:1 release is given as first condition for the drive control unit to detect the drive direction.

9.1 SIGNAL MEASURING AT THE DRIVER CONTROL UNIT

PowerBoss
The Power of Clean

Drive rheostat switch S8:

This switch is located at the accelerator and is closed after pedal actuation. Then the battery plus signal is transferred to the coil of the K4 relay and the relay closes the switching contact.

Relay K4:

After the drive rheostat switch S8 has closed, the battery plus signal applies at the K4 relay's coil and closes the switching contact. This contact is located in series with the direction switch S7 between the control unit A1:X3:1 and S7. Now the battery minus signal can be transferred from A1:X3:1 via the switching contact of K4 and the direction selector switch S7 to the drive control unit.

Battery minus at A4:X51:4 -> forward

Battery minus at A4:X51:5 -> reverse

Now the direction contactors of the drive control unit close contact.

Result for drive direction:

If the drive control unit does not switch the direction contactors after drive direction has been selected and the accelerator actuated, check the above mentioned signals/ voltages, connections, switches etc.

9.1 SIGNAL MEASURING AT THE DRIVER CONTROL UNIT

PowerBoss
The Power of Clean

3. Speed

The speed attained directly depends on the drive rheostat which is actuated via the accelerator pedal.

The max. speed with full throttle is:

Forward ride: **approx. 7.1 km/h**
Reverse ride: **approx. 3.8 km/h.**

With a free-wheeling drive wheel (jacked machine and cold drive motor), the parameters are as follows:

Forward ride: **$I \approx 12.5A$; drive wheel speed: $n \approx 230$ rpm**
Reverse ride: **$I \approx 11.5A$; drive wheel speed: $n \approx 130$ rpm**

To attain a higher final speed in forward ride than in reverse ride, a signal is transferred to the drive control unit.

9.1 SIGNAL MEASURING AT THE DRIVER CONTROL UNIT

PowerBoss
The Power of Clean

Forward ride: attaining 100% of the final speed:

In order to attain 100% of the final speed in forward ride, the battery minus signal has to be transferred from the A1:X3:3 contact of the control unit to the drive control unit

contact A4:X51:11.

Therefore, the contacts A1:X4:4 and A1:X3:3 on the A1 are connected. This link initiates transfer of the battery minus signal from A1:X4:4 contact to the A1:X3:3 contact. Before these transfers may happen, the battery plus signal has to be transferred via the direction switch S7 to the control unit A1.

Information about drive direction to A1:

The S7 drive direction switch is connected to the control unit at the A1:X8:9 and A1:X8:10 contacts. This link allows transfer of the information about the selected drive direction (forward or reverse) to the control unit. This transfer only works if the drive rheostat switch S8 has closed such that the battery plus signal can be transferred to the control unit.

Then **the A1:X4:4 and A1:X3:3 contacts on A1 are connected in forward ride (= 100% of the max. speed) and re-opened in reverse ride (= 50% of the max. speed).**

9.1 SIGNAL MEASURING AT THE DRIVER CONTROL UNIT

PowerBoss[®]
The Power of Clean

50% of the speed apply if:

Driving in reverse mode

The LDS displays low battery status (red LED of LDS lights)

The thermal switch of the drive motor has opened, i.e. the motor is overheated
(error code 3.4.5.1. displayed)

Result for speed:

If the machine should only ride slowly at full speed in forward mode, check the signal transfer/voltages from the direction switch S7 to the control unit and from the control unit to the drive control unit.

9.2 SETTING THE ACCELERATOR PETAL

PowerBoss
The Power of Clean

Setting the drive rheostat switch S8 and the drive rheostat 'R1' at the accelerator pedal is required.

Caution:

Before proceeding to settings at the drive control unit make sure that the drive wheel rotates freely and has no contact with the ground. The setting work has to be executed with the greatest precaution possible to preclude injuries of persons or a movement of the machine, since otherwise the wheels may suddenly start rotating.

Make sure that garments, hair, measuring cables or other are not caught in the rotating wheel (risk of injury!).

Before starting work, set the direction limit switch 'S7' to "0".

9.2 SETTING THE ACCELERATOR PETAL

PowerBoss[®]
The Power of Clean

The 'S8' drive rheostat switch has to be set such that it is not activated in neutral pedal position, i.e. a small gap between the actuation roller of the switch and the eccentric disk of the accelerator is required.

If the accelerator pedal is pressed down, the switch should be actuated (clicking sound) but without bending the actuation lever.

After the switch has been actuated, the resistance between the connections 1 and 4 is approx. 0 Ω

(Caution: Disconnect battery plug before this measurement!).

9.2 SETTING THE ACCELERATOR PETAL

PowerBoss
The Power of Clean

Before further setting of the drive rheostat use a voltmeter to measure at the drive control unit between X51 Pin 3 and Pin 9.

When the accelerator pedal is not pressed down, the voltage has to amount to $U \approx 0\text{ V}$ and increase continuously up to $U \approx 6.5\text{ V}$ as the pedal is pressed down to stop. In order to guarantee a perfect operation, the minimum voltage attained when pressing down the pedal has to be $U = 4.5\text{ V}$.

After the pedal has attained its limit position, the drive rheostat must not be positioned at a stop. A clearance of 2mm is required between the final position of the accelerator and the rheostat stop (check at the adjusting lever of the 'R1' rheostat if required).

If the stop position of the drive rheostat has already been attained with the accelerator

pedal, the drive rheostat may be turned in its oblong holes.

Irrespective of the pedal position, a voltage of approx. $U \approx 10,5\text{ V}$ applies between X51 Pin 3 and Pin 8.

9.3 A4:X51 PLUG ASSIGNMENT



PIN	Plug assignment (measured to battery minus) (X51)
1	not connected
2	Drive control unit release; $U = 24V$ or battery voltage if key switch has closed
3	Drive rheostat; $U = 0V$
4	Forward drive direction; $U = 0V$ after forward mode has been selected and 'S8' drive rheostat switch and contact on control unit A1 have closed.
5	Reverse drive direction; $U = 0V$ after reverse mode has been selected and 'S8' drive rheostat switch and contact on control unit A1 have closed.
6	not connected

9.3 A4:X51 PLUG ASSIGNMENT



PIN	Plug assignment (measured to battery minus) (X51)
•	
•	
• 13	not connected
•	
• 14	not connected
•	
• 15	not connected
•	

10. ERROR REFERENCE CHART WITH INFORMATION ON SERVICE DISPLAY



Error code in display	Malfunction	Remarks
1.2.5.2.	Thermal protector of brush motor	of Brush motor fan ok? Wire broken (break contact circuit)? Measure operating current (approx. 36.5A max; to preclude motor overload due to uneven ground conditions 32A max. should not be exceeded during operation) Check carbon brushes
1.2.6.1	Block protection of brush motor	Measure operating current (36.5A max.; refer to code 1.2.5.2.)

10. ERROR REFERENCE CHART WITH INFORMATION ON SERVICE DISPLAY



Error code in display	Malfunction	Remarks
1.2.6.3.	Block protection of brush head lifting element	Jammed? Measure operating current (5.0A max.) Correct Dip switch setting on power electronic module (A2)?
1.4.6.1	Block protection of squeegee lifting element	Jammed? Measure operating current (1.5A max.) Correct Dip switch setting on power electronic module (A2)?

10. ERROR REFERENCE CHART WITH INFORMATION ON SERVICE DISPLAY



Error code in display	Malfunction	Remarks
1.2.5.2.	Thermal protector of brush motor	Brush motor fan ok? Wire broken (break contact circuit)? Measure operating current (approx. 36.5A max; to preclude motor overload due to uneven ground conditions, 32A max. should not be exceeded during operation) Check carbon brushes
1.2.6.1	Block protection of brush motor	Measure operating current (36.5A max.; refer to code 1.2.5.2.)

10. ERROR REFERENCE CHART WITH INFORMATION ON SERVICE DISPLAY



Error code in display	Malfunction	Remarks
1.2.6.3.	Block protection of brush head lifting element	Jammed? Measure operating current (5.0A max.) Correct Dip switch setting on power electronic module (A2)?
1.4.6.1	Block protection of squeegee lifting element	Jammed? Measure operating current (1.5A max.) Correct Dip switch setting on power electronic module (A2)?

10. ERROR REFERENCE CHART WITH INFORMATION ON SERVICE DISPLAY



Error code in display	Malfunction	Remarks
3.1.6.1.	Fuse of power electronic module (A2)	Check all fuses, If the code for blocking protection of lifting element for brushes or squeegee appears, check these; Check water pump and water valve if 10A/80V fuse was defective
3.1.6.7.	Fuse of control unit (A1)	Check 7.5 A / 32 V fuse Check connection with control unit

10. ERROR REFERENCE CHART WITH INFORMATION ON SERVICE DISPLAY



Error code in display	Malfunction	Remarks
3.2.1.1.	LDS defective	Measure approx. battery voltage on control unit A1.X2 PIN 1 and 4 , if voltage is not ok check plug contacts for corrosion etc. and cable connection up to battery plug; check Dip-switch setting for battery type if voltage and connection are ok replace control unit (A1)
3.4.1.1.	Error of drive rheostat switch	Check drive rheostat switch S7

10. ERROR REFERENCE CHART WITH INFORMATION ON SERVICE DISPLAY



Error code in display	Malfunction	Remarks
3.4.5.1.	Thermal protector of drive motor	Is drive motor fan OK? Does travel drive respond smoothly? Parking brake setting ok? Did you perform an extended uphill ride? Wire broken (wiring to thermal switch or connectors badly plugged? Measure operating current in "A2" motor line using a clip-on current transformer at full throttle on level ground (approx. 26A max. at transport ride and 30A max. at cleaning ride)

For Internal Office Use Only

10. ERROR REFERENCE CHART WITH INFORMATION ON SERVICE DISPLAY



Error code in display	Malfunction	Remarks
4.1.2.1.	Power electronic module (A2) not recognised	Check connection between control unit (A1) and power electronic module (A2) control unit A1:X10:PIN 1 and PIN 2 and power electronic module (A2:X22:PIN 1 and 2); Check voltage supply of power electronic module (A2)

10. ERROR REFERENCE CHART WITH INFORMATION ON SERVICE DISPLAY



Error code in display	Malfunction	Remarks
4.1.3.1.	Power electronic module (A2) no response (timeout)	Check connection between control unit (A1) and power electronic module (A2) control unit A1:X10:PIN 1 and PIN 2 and power electronic module (A2:X22:PIN 1 and 2); Check voltage supply of power electronic module (A2)
4.6.1.1.	Internal control unit error	Check contacts for corrosion and plugs, check voltage supply, if ok but still error code displayed replace control unit

10. ERROR REFERENCE CHART WITH INFORMATION ON SERVICE DISPLAY



Error code in display	Malfunction	Remarks
4.6.2.1.	CAN bus error (no response - timeout)	Check 2 A / 32 V circuit breaker of control unit (A1), check wiring between A1:X10:PIN 1 and PIN 2 and power electronic module (A2:X22:PIN 1 and 2) as well as the contacts and plugs, check voltage supply of power electronic module (A2) and control unit (A1); check resistors (120 Ω) (60 Ω caused by parallel connection) If this error occurs in connection with code 4.1.2.1. or 4.1.3.1. first check as indicated there; if required, replace the power electronic module (A2)

10. ERROR REFERENCE CHART WITH INFORMATION ON SERVICE DISPLAY



Error code in display	Malfunction	Remarks
4.6.3.1.	CAN bus error (bus error)	Check wiring between A1:X10:PIN 1 and PIN 2 and power electronic module (A2:X22:PIN 1 and 2) as well as the contacts and plugs, check voltage supply of power electronic module (A2) and control unit (A1); check resistors (120 Ω (60 Ω caused by parallel connection))

10. ERROR REFERENCE CHART WITH INFORMATION ON SERVICE DISPLAY



Error code in display	Malfunction	Remarks
4.6.3.2.	CAN bus error (overrun)	Check wiring between A1:X10:PIN 1 and PIN 2 and power electronic module (A2:X22:PIN 1 and 2) as well as the contacts and plugs, check voltage supply of power electronic module (A2) and control unit (A1); check resistors (120 Ω) (60 Ω caused by parallel connection)

10. ERROR REFERENCE CHART WITH INFORMATION ON SERVICE DISPLAY

PowerBoss[®]
The Power of Clean

Error code in display	Malfunction	Remarks
4.6.5.1.	Incorrect machine type setting	Check machine type setting of Dip switch A on control unit A1
4.6.5.2.	Set option impossible	Too many options set at Dip switch B on control unit A1?
4.6.5.3.	Too many modules in the machine	Are all options set at Dip switch B on control unit A1? Have all codes been correctly set at all electronic modules?

For Internal Office Use Only

11. ADJUSTMENT OF DISC BRAKE

PowerBoss[®]
The Power of Clean

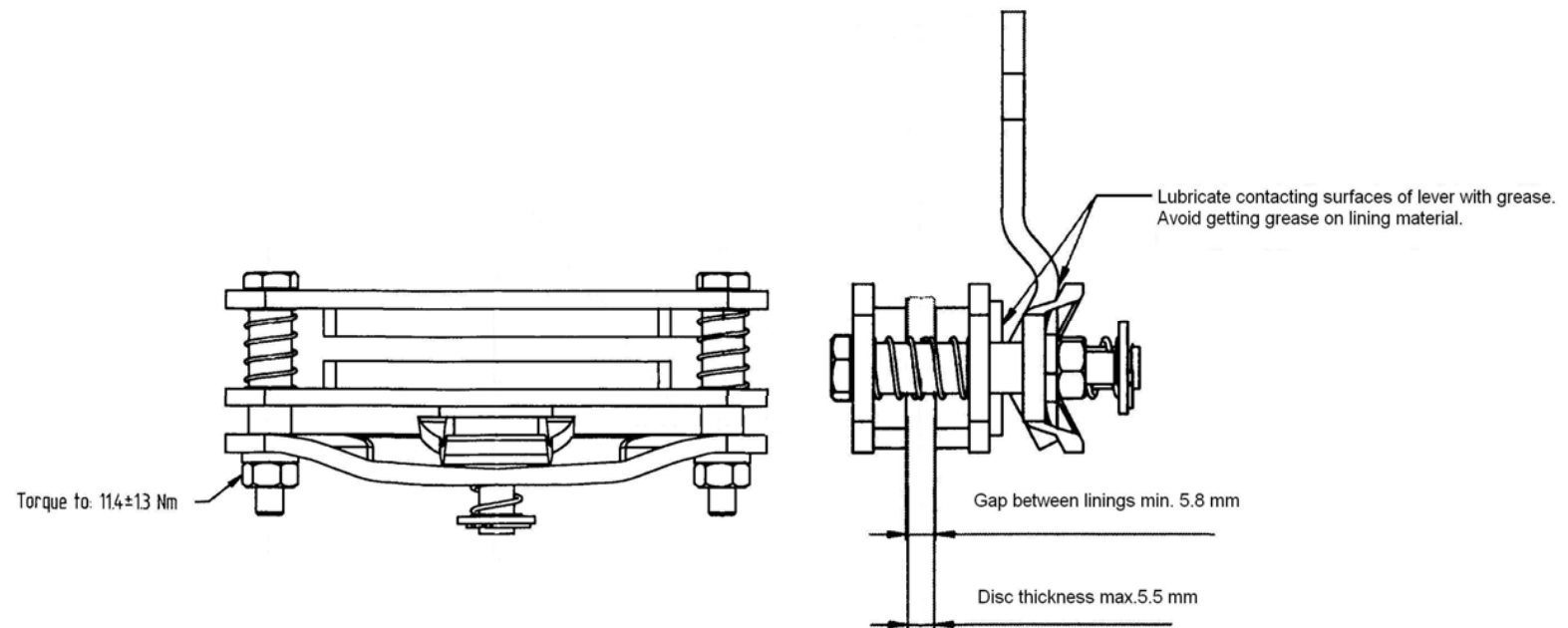

For Internal Office Use Only